



A Furukawa Company

LXE Cable Sheath Preparation

CONTENTS	SECTION
GENERAL	1
PRECAUTIONS	2
END-PREP SHEATH REMOVAL	3
MID-SPAN SHEATH REMOVAL	4
CORE TUBE REMOVAL	5
CLEANING FIBERS & RIBBONS	6

1. General

- 1.1 This document contains sheath preparation instructions for OFS LXE cable sheaths (metallic and dielectric) containing any of the following core types: LightPack®, AccuRibbon®, and AccuRibbon DC.
- 1.2 LXE cables contain either 2 or 4 linear strength members positioned 180° opposite of each other in the cable jacket. This arrangement of the strength members allows easy access to the core tube in mid-span fiber access applications.
- 1.3 LightPack LXE cables are available with 4 – 96 fibers in a gel-filled central core tube. The individual fibers in the LightPack core are bundled together with two helically-applied binder threads in groups of 4 to 12 fibers. AccuRibbon LXE cables are available with 12 – 864 fibers in a gel-filled central core tube. AccuRibbon DC cables are available with 12 – 864 fibers in a gel-free central core tube. OFS AccuRibbon is comprised of 12- or 24-fibers bonded together in a matrix material. The 12-fiber ribbons are used in cables containing 12 – 216 fibers. The 24-fiber ribbons are used in cables containing 240 – 864 fibers.

2. Precautions

- 2.1 LXE cables are designed to meet the rigors of aerial, direct buried, and underground conduit installations. However, care must be exercised during installation to ensure that the maximum rated cable load (MRCL) is not exceeded and the minimum bend diameter is not violated.
- 2.2 The MRCL for standard LXE cable is 600 pounds (2700 N). This is the maximum tensile force that may be applied to the cable during short-term installation conditions, e.g., during an underground installation in conduit or innerduct. For long term conditions, the maximum recommended cable load is 180 pounds (800 N).
- 2.3 Cable minimum bend diameters are defined for both dynamic and static conditions. The dynamic condition applies to a cable that may be exposed to the MRCL, e.g., pulling the cable around a sheave or capstan. The static condition applies to a cable that is exposed only to low tension, e.g., an installed cable that is racked in a handhole or manhole. The maximum recommended cable tension under static conditions is 180 pounds (800 N).

2.4 Cable minimum bend diameters¹ are dependent on the cable diameter and fiber count and are expressed as a multiple of the cable diameter. For static conditions, the minimum recommended bend diameter for cables containing up to 216 fibers is 20 × cable outside diameter (OD). For dynamic conditions, the minimum recommended bend diameter is 40 × OD. For cables containing 240 – 864 fibers, the minimum recommended bend diameter is 30 × OD for static conditions and 40 × OD for dynamic conditions. The minimum bend diameters for OFS LXE-type cable are summarized in Table 1.

2.5 The minimum recommended storage-coil diameter for cables containing up to 216 fibers is 18 inches. For cables containing 240 – 864 fibers, the minimum recommended storage-coil diameter is 40 × OD. Minimum recommended storage-coil diameters are summarized in Table 1.

Table 1 – Minimum Recommended Bend Diameters and Storage Coil Diameters for LXE-Type Cable

Cable Type	Fiber Count	Cable Diameter	Minimum Bend Diameter		Minimum Storage Coil Diameter
			Unloaded 20 × OD	Loaded 40 × OD	
LightPack and 12-fiber AccuRibbon			Unloaded 20 × OD	Loaded 40 × OD	
LightPack LXE-DE (Dielectric)	4 - 48	0.51" (13.0 mm)	11" (26 cm)	21" (52 cm)	18" (46 cm)
	50 - 96	0.61" (15.5 mm)	13" (31 cm)	25" (62 cm)	18" (46 cm)
LightPack LXE-ME (Metallic)	4 - 24	0.45" (11.4 mm)	9" (23 cm)	18" (46 cm)	18" (46 cm)
	26 - 48	0.51" (13.0 mm)	11" (26 cm)	21" (52 cm)	18" (46 cm)
	50 - 96	0.61" (15.5 mm)	13" (31 cm)	25" (62 cm)	18" (46 cm)
AccuRibbon LXE AccuRibbon DC	12 - 48	0.51" (13.0 mm)	11" (26 cm)	21" (52 cm)	18" (46 cm)
	60 - 144	0.61" (15.5 mm)	13" (31 cm)	25" (62 cm)	18" (46 cm)
	156 - 216	0.71" (18.0 mm)	15" (36 cm)	29" (72 cm)	18" (46 cm)
24-fiber AccuRibbon			Unloaded 30 × OD	Loaded 40 × OD	Coil Diameter 40 × OD
AccuRibbon LXE AccuRibbon DC	240	0.71" (18.0 mm)	22" (54 cm)	29" (72 cm)	29" (72 cm)
AccuRibbon LXE AccuRibbon DC (Dielectric)	264 - 576	0.78" (19.8 mm)	24" (60 cm)	32" (80 cm)	32" (80 cm)
	264 - 432	0.78" (19.8 mm)	24" (60 cm)	32" (80 cm)	32" (80 cm)
AccuRibbon LXE AccuRibbon DC (Metallic)	264 - 576	0.84" (21.3 mm)	26" (64 cm)	34" (86 cm)	34" (86 cm)
AccuRibbon LXE (Dielectric)	720 - 864	0.95" (24.1 mm)	29" (73 cm)	38" (95 cm)	38" (95 cm)
AccuRibbon LXE AccuRibbon DC (Metallic)	720 - 864	1.05" (26.6 mm)	32" (80 cm)	42" (107 cm)	42" (107 cm)

¹ Some cable manufacturers specify minimum bend-radius rather than minimum bend-diameter. Minimum bend-diameter can be converted to minimum bend-radius by dividing the minimum bend-diameter by 2. For example, the minimum recommended bend-radii for OFS cables containing up to 216 fibers are 10 × OD and 20 × OD, respectively, for static and dynamic conditions.

3. End-Prep Sheath Removal

3.1 LXE Metallic (ME) Cable: The following instructions describe end-prep jacket removal for LXE-ME (metallic) cables. ***Work gloves and safety glasses are recommended for use during the cable prep operation.***

1. Consult the closure instructions for the length of cable jacket that must be removed. Place a tape mark at the required length from the end of the cable (Figure 1).
2. Ring-cut the outer jacket at the tape mark.
3. At the end of the cable, shave off about 6 inches of the outer jacket to expose the strength members and ripcords (Figure 1).
4. Pull each ripcord through the outer jacket to the tape mark (Figure 1).
5. Cut each ripcord flush with the tape mark.

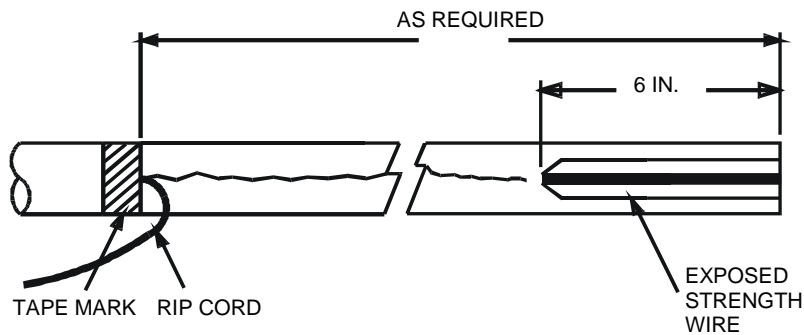

Figure 1 – Opening the outer cable jacket.

6. Use a pair of diagonal pliers to begin separating the outer jacket from the corrugated metal. Peel back and remove both sections of the plastic jacket from the underlying armor (Figure 2). Flex the plastic jacket at the ring cut to separate it from the cable.
7. Consult the closure instructions to determine the length of strength wire that is required to clamp the cable in the closure. Cut both strength members as required and carefully spread them to gain access to the corrugated metal (Figure 2).

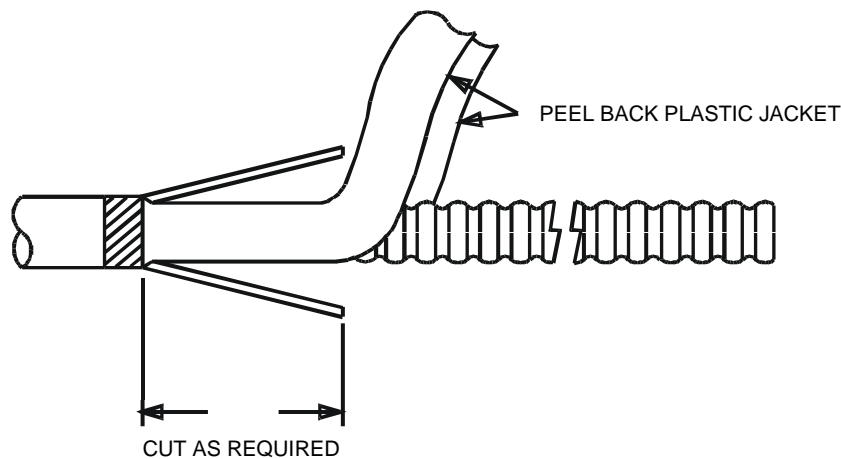

Figure 2 – Remove the outer cable jacket.

8. Snip the armor overlap about 3 inches from the end of the cable. Peel off the 3-inch section of corrugated metal to expose the inner ripcord and core tube (Figure 3). **Caution: The exposed edges of the metal armor are very sharp. Use work gloves to avoid injury.**
9. Consult the closure instructions and determine the length of armor that is required to bond the cable in the closure. Mark the armor layer where it will be cut and removed.
10. Snip the end of the corrugated metal opposite of the armor overlap to create a starting point for the ripcord. Wrap the armor ripcord around the tip of needle nose pliers and pull the ripcord through the armor, opposite of the armor overlap, to the position where the armor will be cut and removed (Figure 3). Pull the ripcord at a 90° angle relative to the cable axis to avoid ripcord breakage.
11. Peel back the two sections of armor and cut at the required length.
12. Cut the inner ripcord flush with the armor.
13. Skip to Section 5 for core tube removal instructions.

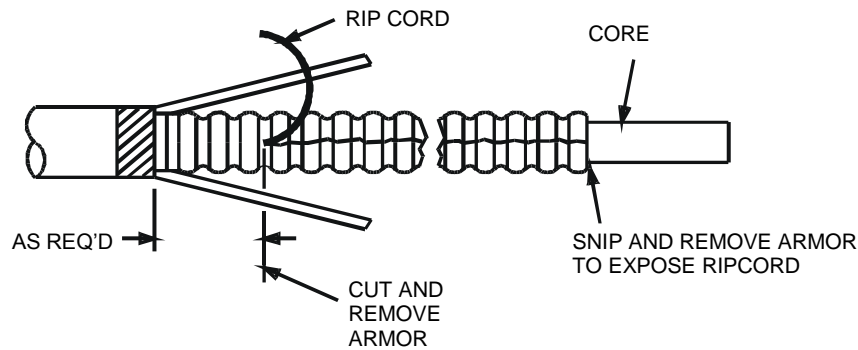

Figure 3 – Remove the corrugated armor layer.

3.2 LXE Dielectric (DE) Cable: The following instructions describe end-prep jacket removal for LXE-DE (dielectric) cable. **Work gloves and safety glasses are recommended for use during the cable prep operation.**

1. Consult the closure instructions for the length of cable jacket that must be removed. Place a tape mark at the required length from the end of the cable (Figure 4).
2. Ring-cut the outer jacket at the tape mark.
3. At the end of the cable, shave off about 6 inches of the outer jacket to expose the strength members and ripcords (Figure 4).
4. Pull each ripcord through the outer jacket to the tape mark (Figure 4).

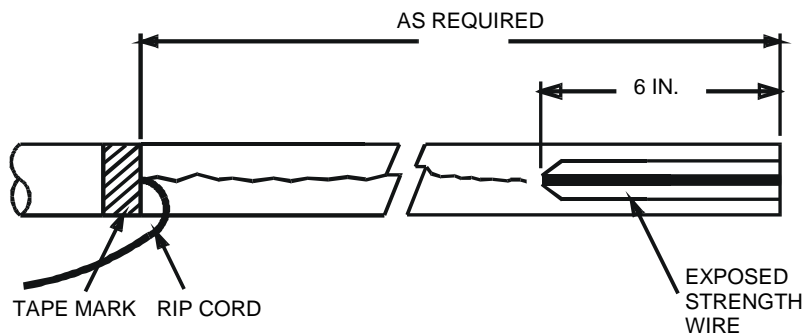

Figure 4 – Open the outer cable jacket.

5. Peel the two sections of outer jacket back to the tape mark.
6. Flex the two sections of outer jacket at the ring cut to separate and remove them from the cable.

7. Cut the ripcords flush at the tape mark.
8. Consult the closure instructions to determine the strength-member length that is required to clamp the cable in the closure. Cut both strength members as required.
9. Skip to Section 5 for core tube removal instructions.

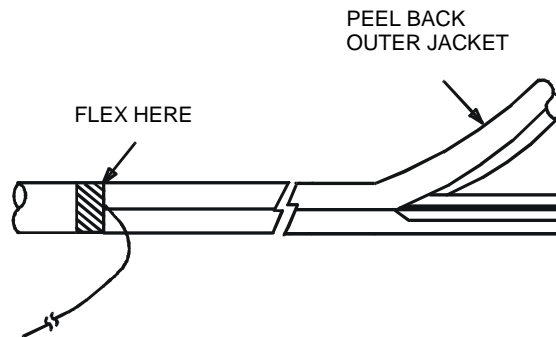

Figure 5 - Remove the outer cable jacket to expose core tube

4. Mid-Span Sheath Removal

4.1 LXE Metallic (ME) Cable: The following instructions describe mid-span jacket removal for LXE-ME (metallic) cables. *Work gloves and safety glasses are recommended for use during the cable prep operation.*

1. Consult the closure documentation to determine the length of cable jacket that must be removed for mid-span splicing. Place tape marks on the cable indicating the section of cable jacket that will be removed (Figure 6).
2. Use a knife to ring-cut the outer jacket at both tape marks (Figure 6).
3. At one tape mark, shave off about 6 inches of the outer jacket to expose the strength members and ripcords (Figure 6).
4. Cut the exposed ripcords at the tape mark and pull each ripcord through the outer jacket to the opposite tape mark (Figure 6)
5. Cut each ripcord flush with the tape mark.

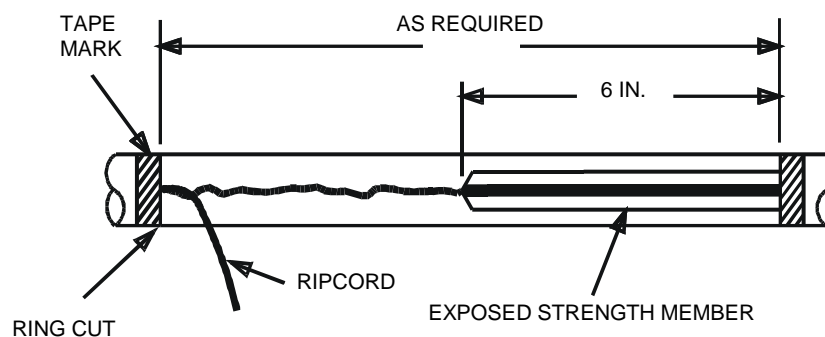

Figure 6 - Remove the outer cable jacket.

6. Use a pair of diagonal pliers to separate the outer jacket from the corrugated metal. Peel back and remove both sections of the outer jacket (Figure 7).
7. Consult the closure instructions to determine the length of strength wire that is required to clamp the cable in the closure. Cut each strength member at the required length (Figure 7).
8. Carefully spread the strength members to gain access to the corrugated metal (Figure 7).

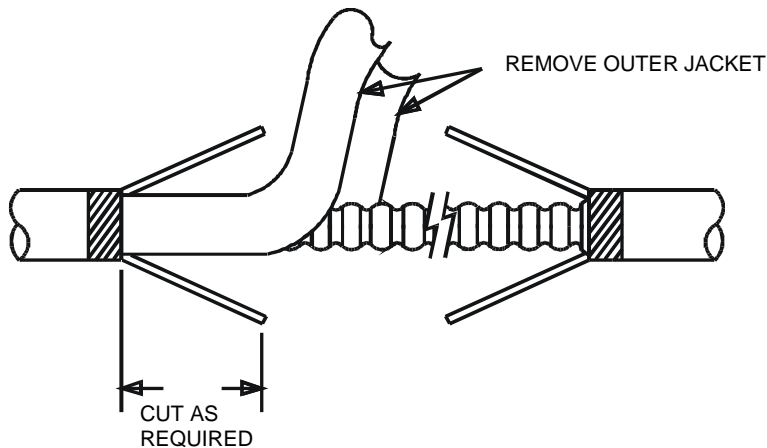

Figure 7 - Remove the outer jacket from the corrugated metal.

9. Consult the closure instructions to determine the length of corrugated armor that is required to bond the cable in the closure. Snip the armor overlap at the required length at one end of the cable opening (Figure 8).
11. Snip the armor overlap again about 3 inches away from the first snip (Figure 8).
12. Peel off and remove the 3-inch section of corrugated metal to expose the core tube and ripcord (Figure 8).

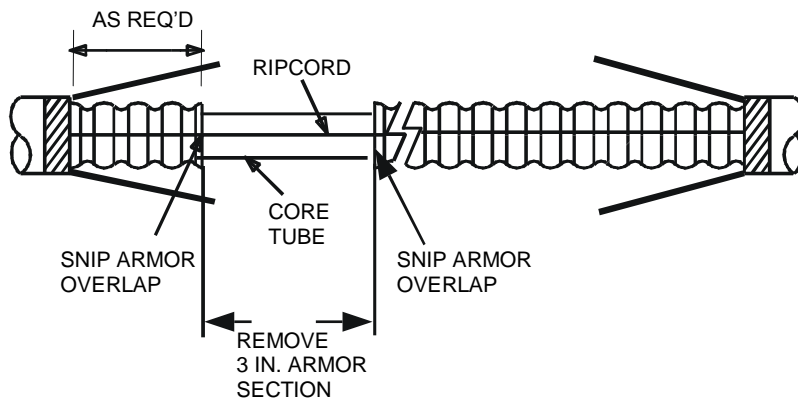

Figure 8 – Remove a 3-inch section of armor to expose the core tube and ripcord.

13. Cut the armor ripcord near the tape mark (Figure 9).
14. Snip the end of the corrugated metal opposite of the armor overlap to create a starting point for the ripcord. Wrap the armor ripcord around the tip of needle nose pliers and pull the ripcord through the armor, opposite of the armor overlap, to the required length at the opposite end of the sheath opening (Figure 9). Pull the ripcord at a 90° angle relative to the cable axis to avoid ripcord breakage.

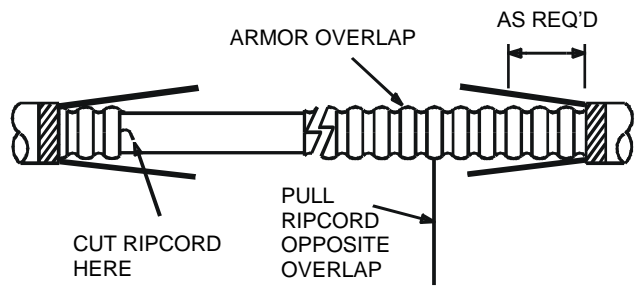

Figure 9 – Use the ripcord to open the armor.

15. Separate the armor at the overlap and peel off the two halves of the corrugated metal to the required length (Figure 10).
16. Cut the corrugated metal as required (Figure 10).

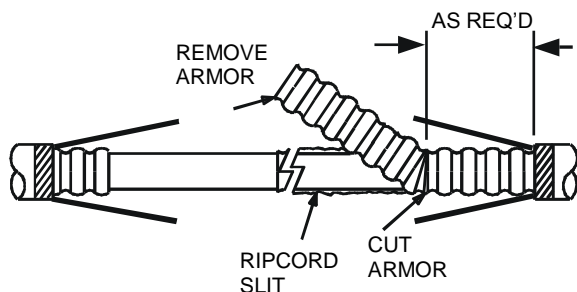

Figure 10 – Remove the armor from the core tube.

4.2 LXE Dielectric Cable: The following instructions describe mid-span jacket removal for LXE-DE (dielectric) cable. *Work gloves and safety glasses are recommended for use during the cable prep operation.*

1. Consult the closure instructions to determine the length of cable jacket that must be removed for the mid-span splicing application. Place tape marks on the cable to indicate the length of cable jacket that will be removed (Figure 11).
2. Use a knife to ring-cut the outer jacket at both tape marks.
3. Shave off about 6 inches of the outer jacket at one of the tape marks to expose the fiberglass strength members and ripcords (Figure 11).

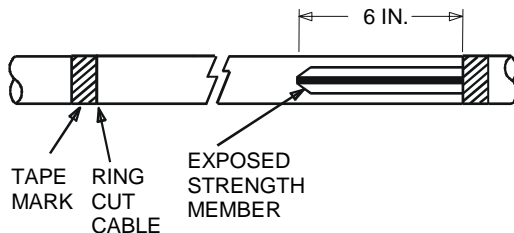

Figure 11 – Ring cut the outer jacket and expose the ripcords at one end.

4. Cut the exposed ripcords near the tape marks (Figure 12).
5. Pull each ripcord through the outer jacket to the opposite tape mark (Figure 12).
6. Cut both ripcords flush with the tape marks.

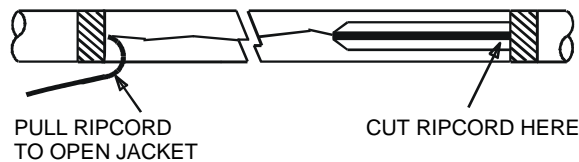

Figure 12 – Pull the ripcords through the outer jacket.

7. Flex the cable at the ring cut to separate the outer jacket. Use diagonal pliers to lift an edge of the outer cable jacket. Peel back and remove the two halves of the outer jacket (Figure 13).
8. Cut the ripcords flush at both ends of the sheath opening.
9. Consult the closure instructions to determine the length of strength member that is required to clamp the cable in the closure. Cut the strength members at the required length.

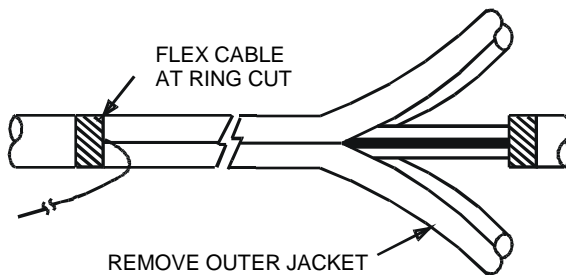

Figure 13 – Pull ripcord to open outer jacket.

5. Core Tube Removal

5.1 **End Prep:** This section describes the core tube removal procedure for end prep access. Additional information can be found in OFS practice IP-054, *1050 Series Core Tube Entry Tools*.

1. Consult the closure instructions to determine the length of central core tube that is needed inside the closure. Measure and mark the core tube as required.
2. Use the appropriate 1050-type tool to ring-cut the core tube at the required length (Figure 14). Note: If more than 5-feet of tube is removed, cut and remove the tube in several shorter sections.
3. Flex the core tube at the ring cut to separate and remove the core tube.

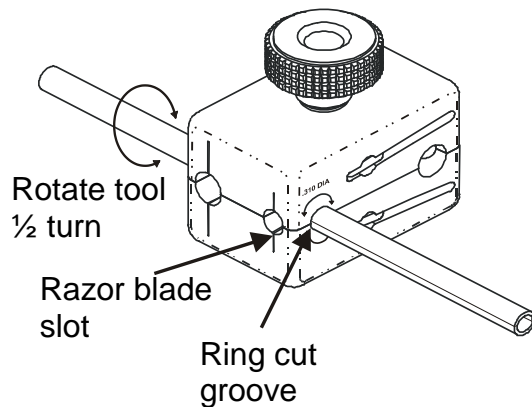

Figure 14 – Ring-cut the core tube at the required length.

5.2 Mid-Span Access: This section describes the core tube removal procedure for mid-span access applications. Additional information can be found in OFS practice IP-054, *1050 Series Core Tube Entry Tools*.

1. Consult the closure instructions to determine the length of core tube that is recommended inside the closure. Mark the section of tube that will be removed.
2. Use the appropriate 1050-type tool to split the core tube between the two marks (Figure 15).
3. Use the 1050 tool to ring-cut the core tube at both marks (Figure 14). Remove the core tube to expose the fibers.

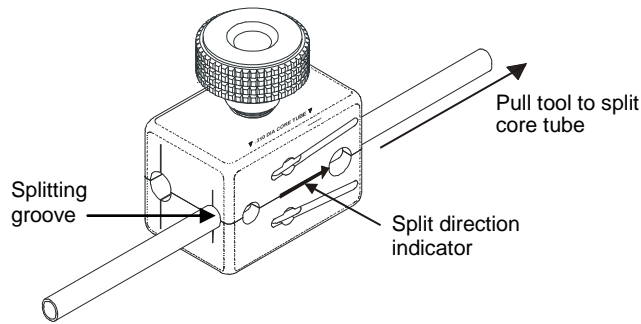

Figure 15 – Use the 1050-tool to split the core tube.

6. Cleaning Fibers and Ribbons

6.1 LightPack Core

1. The individual fibers in the LightPack core are bundled together with two helically-applied binder threads. To separate the fiber bundles, hold all of the fibers together and carefully pull one binder thread as shown in Figure 16. The binder will tighten around one bundle of fibers separating them from the remaining fibers.
2. To maintain bundle identification, loosely tie the binder around the fiber bundle adjacent to the core tube.
3. Using a dry wipe, remove excess cable-gel from the fiber bundles. An approved cable-gel remover (see Table 2) may also be used to clean the fibers.

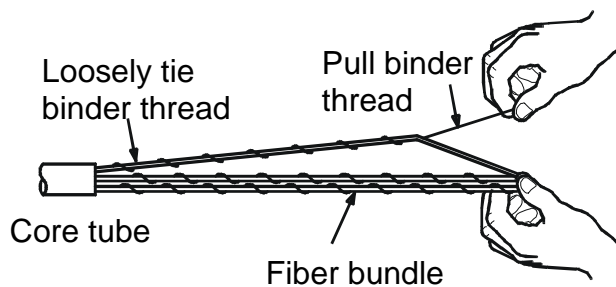

Figure 16 – Separate the LightPack bundles by carefully pulling the binders.

Table 2 – Approved Cable-Gel Removers ²
HydraSol ³
D'Gel ⁴

6.2 AccuRibbon Core

1. Inspect the ribbon ends. If the ribbon ends were damaged or split during installation, trim the ribbon ends prior to cleaning. This will prevent propagation of ribbon splits during cleaning.
2. Clean the ribbon stack by slightly fanning out the ribbons and wiping the majority of the cable-gel from the ribbons with clean, dry paper towels. Wipe the ribbons from the inside end towards the free end of the ribbons. For a mid-span access, wipe the ribbons in one direction.
3. Clean the individual ribbons by separating them from the ribbon stack and wiping with a clean, dry paper towel. Apply uniform pressure along the ribbon surface during the wiping operation (Figure 17). **Caution: Excessive squeezing pressure and/or excessive twisting may cause ribbon splitting. Handle the ribbons with care!**
4. After the majority of the cable gel has been removed, an approved cable-gel remover (Table 2) can be used to clean the residual cable-gel from the ribbon. After using the cable-gel remover, wipe the ribbon with a clean, dry paper towel to remove any residual solvents from the ribbon. **Caution: Do not soak the ribbons in cable-gel removers as this may cause swelling and delamination of the matrix material. Do not use ethyl alcohol to clean AccuRibbon products. Ethyl alcohol may cause swelling and delamination of the matrix material, fiber separation, and removal of marking ink.**

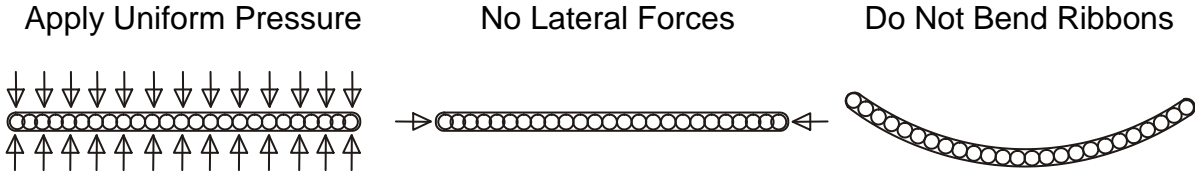

Figure 17 – AccuRibbon handling precautions.

6.3 AccuRibbon DC Cable

AccuRibbon DC is a totally dry cable and does not contain any cable-gel material. Consequently, no ribbon cleaning procedure is required. At most, the end of the ribbon may need to be wiped with an alcohol soaked towel prior to splicing to remove dust and/or residual water blocking powder.

² This list of cable-gel removers is not intended to be comprehensive, but lists the products that have been evaluated and approved for use. Equivalent products known to be compatible with the fibers, ribbon-matrix material, and marking ink may be substituted.

³ Hydrosol is a registered trademark of American Polywater Corporation, Stillwater, MN.

⁴ D'Gel is a registered trademark of PT Technologies, Tucker, GA.

For additional information please contact your sales representative. You can also visit our website at www.ofsoptics.com or call 1-888-FIBERHELP (1-888-342-3743) from inside the USA or 1-770-798-5555 from outside the USA.

AccuRibbon and LightPack are registered trademarks of OFS FITEL, LLC.

OFS reserves the right to make changes to the document at any time without notice. This document is for informational purposes only and is not intended to modify or supplement any OFS warranties or specifications relating to any of its products or services. OFS makes no warranty or representation with respect to the non-OFS products or non-OFS companies mentioned in this document.

***Copyright © 2018 OFS FITEL, LLC.
All rights reserved, printed in USA.***